

# INTEGRATION

**SHURE**

## + MXA NETWORK MUTE BUTTON

The MXA Network Mute Button is a configurable PoE-powered mute button accessory designed for Shure networked audio products, including Microflex® Advance™ Array Microphones as well as the IntelliMix® P300 and IntelliMix Room DSPs, and ANIUSB-MATRIX. One or many of the low-profile touch sensitive mute buttons can be configured to mute one or multiple microphones, depending on user needs or room configurations.

### Features

- Designer System Configuration software for easy setup and configuration
- SystemOn™ Asset Management for remote management & troubleshooting
- PoE powered
- Compatible with third party control systems via programmable control strings
- LED status ring with configurable colors and brightness
- Configurable as toggle, push to talk and push to mute functionality
- IP1X rated
- Easy table installation in 1" (25mm) or 7/8" (22mm) holes



INSTALLATION

SHURE



SHURE

# INSTALLATION SOLUTIONS

MXA920 Ceiling Array Microphones are designed for suspension, pole and flush mounting in metric or imperial formats. The sleek, linear form factor of the MXA710 allows for placement virtually anywhere in a meeting space, including on a wall, around a display, ceiling, or into a conference room table. MXA310 Table Array Microphones feature through-the-table mounting kits. The A310-FM mounting accessory also allows flush mounting in a table.



# INSTALLATION

## MXA920 CEILING ARRAY MOUNTING OPTIONS

### Integrated Vibration Isolation

Prevents transmission of mechanical noise through the microphone.

### Plenum-Rated

UL 2043 suitable for air handling spaces and plenum compliant (-S models only)

### Dust Protection

IEC 60529 IP5X Dust Protected



MXA910W-US installation shown

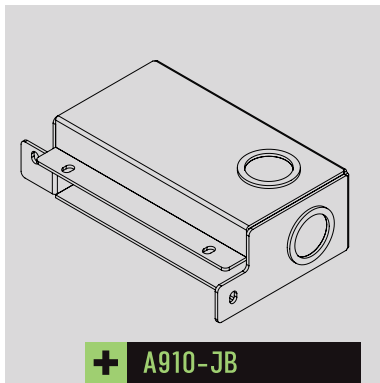

Allows the Ethernet cable connected to the array to be installed inside flex conduit.



Requires A910-HCM accessory

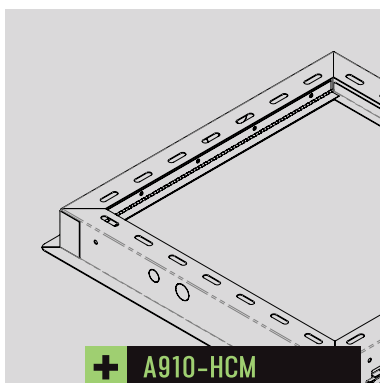

Hard Ceiling Mount  
Can be pre-installed in the ceiling and the MXA910 installed later using the access door. Provides knockouts for conduit connections.



# INSTALLATION

## MXA310 TABLE ARRAY MOUNTING OPTIONS

### + TABLE ARRAY MOUNTING KIT (INCLUDED)

Cable management solutions for on-the-table or through-the-table applications; includes mounting tube/wingnut.

MXA310 retrofits existing Shure table mounted MX395, MX396, MX392 boundary microphones.



### + A310-FM FLUSH MOUNT (OPTIONAL)

Allows MXA310 Table Array to be mounted flush in the table; includes rubber isolation to prevent mechanical vibrations.

Available in black and aluminum finishes; paintable to match table surface.



## MXA710 LINEAR ARRAY MOUNTING OPTIONS

### + SUSPENSION MOUNT



### + BELOW DISPLAY WITH THIRD-PARTY MOUNT



### + FLUSH MOUNT KIT



### + WITH A710-DS DESKTOP STAND



## EXPRESSIVE FINISHES

Ceiling and Table Array microphones are available in black, white and aluminum finishes to match room aesthetics or the finishes of other AV system components. The Ceiling Array microphone can also be custom-painted to fit your environment.

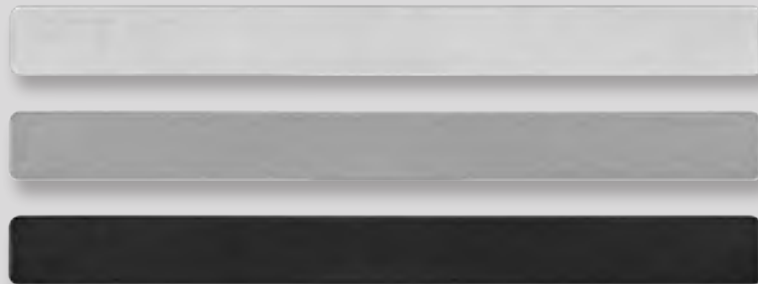
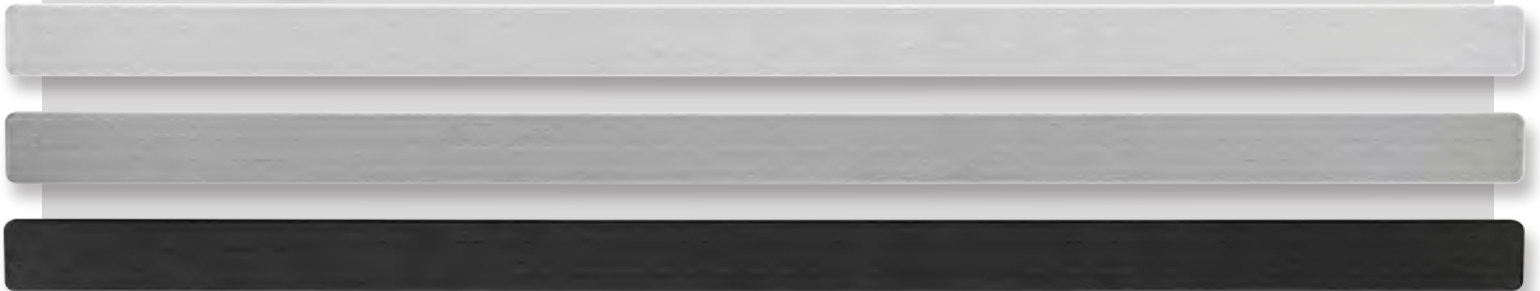

A man in a light blue shirt is shown in profile, adjusting a large, white, rectangular Shure microphone mounted on a stand. The scene is dimly lit, with the background showing a grid-like pattern, possibly a window or a wall. The overall mood is professional and focused.

**SHURE**

**SHURE**

# EFFORTLESS MEETINGS

SHURE MICROFLEX® COMPLETE WIRELESS



**SHURE**

**SHURE**

# THE FREEDOM TO COLLABORATE

Microflex Complete Wireless (MXCW) unleashes the potential of your teams to do their best. The all in one wireless conferencing system makes any room the meeting room. Classroom to boardroom, whatever the seating configuration, MXCW is wireless that just works, allowing you and your team to focus on what's important.

# ADVANTAGES

**SHURE**



Innovative interference detection technology avoids wireless issues before they are even noticed.

## WORRY-FREE WIRELESS

## QUICK SETUP

Go from "cart to conference" in minutes – allowing your team to focus on the meeting, not the equipment.



## WORKS IN ANY ROOM

From flexible meeting spaces to high profile historic venues, Microflex Complete Wireless goes anywhere your meetings take you.

## NOTHING ELSE TO BRING

With only three core system components, MXCW ensures you always have the right equipment for the next important discussion.



Tackle even the most complex meeting needs with onboard features including voting, agenda management, and interpretation.

## POWERFULLY SCALABLE

## GREAT SOUND FOR EVERY PARTICIPANT

A dedicated, high-quality loudspeaker at each unit provides clear, intelligible audio for everyone involved.

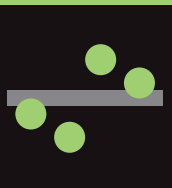



# SIMPLE, YET SCALABLE

WITH ONLY THREE SYSTEM COMPONENTS,  
YOUR MEETING CAN BE SET UP IN NO TIME.

## + MXCW640 WIRELESS TOUCHSCREEN CONFERENCE UNIT

- Chairman, Delegate, Ambient Mic, Listener and Remote Caller roles
- Dual Delegate role allows two participants to share one conference unit
- 4.3-inch / 110 mm capacitive touchscreen display to view meeting controls, speak/request list, voting, etc.
- 2 channel selectors, each with a 3.5 mm headphone jack
- Battery life of up to 11 hours

*Shown with MXC416 16" Gooseneck Microphone*

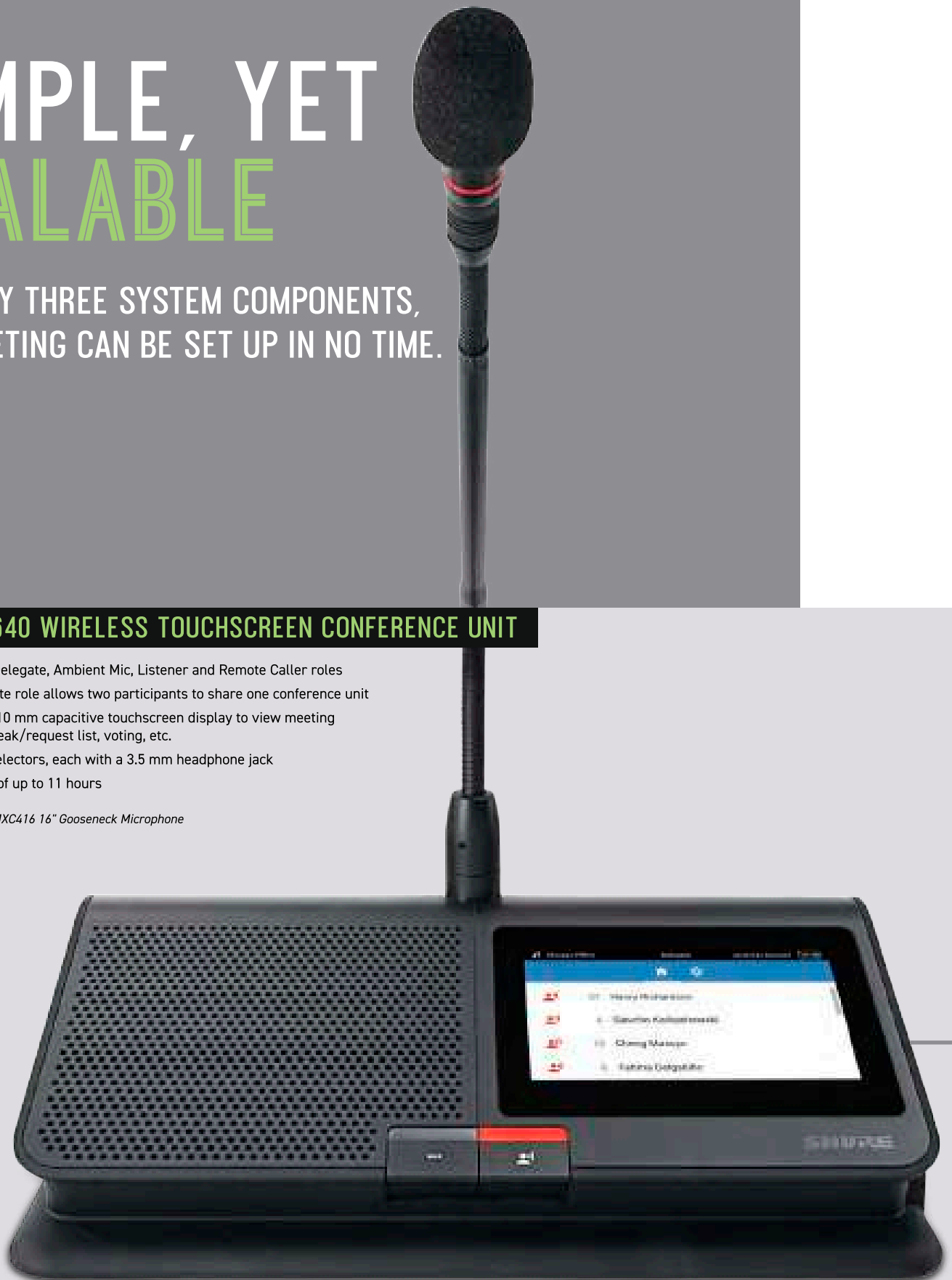

# COMPONENTS

**SHURE**

## + MXCWAPT WIRELESS ACCESS POINT TRANSCEIVER

- Controls up to 125 wireless conference units
- Automated frequency coordination
- Interference detection & avoidance
- AES-128 wireless encryption
- Dante™ digital networking enables routing of 10 audio channels in/out over Ethernet to any Dante-equipped device



INTEGRATED TOUCHSCREEN VOTING



VIEW VOTING RESULTS ON SCREENS



SPEAKER LIST FOR REAL TIME MEETING MANAGEMENT

## COMPONENTS

**SHURE**

### + MXCWNC NETWORKED CHARGING STATION

- Networked Charging Station for up to 10 SB930 batteries
- Fully charges 10 batteries in 4 hours
- Remotely monitor charge levels in hours and minutes
- Integrated test button and 5-segment LED to display charge level
- Storage mode protects batteries by storing them at a safe charge level that preserves battery health over time

### + SB930 INTELLIGENT RECHARGEABLE LI-ION BATTERY



### + MICROFLEX COMPLETE GOOSENECK MICROPHONES

Series of Microflex multipin gooseneck microphones for use with MXC/MXCW conference units only

- Commshield® Technology for excellent RF noise immunity
- Available Dualflex gooseneck accommodates shared use or standing speakers
- Choice of 6 inch/15 cm, 16 inch/40 cm, 20 inch/50 cm, or 25 inch/63 cm lengths
- Built-in bi-color (red/green) LED illuminates when mic is active
- Choice of cardioid or mini shotgun polar pattern
- Compatible with omni, supercardioid and mini-shotgun MX-series cartridges to match seating layout or acoustic conditions



## ADVANTAGES

**SHURE**

# MONITOR & CONTROL

Microflex Complete Wireless includes an intuitive and powerful browser-based control interface for management of all system features, including audio levels, RF settings and more.



Adjust audio output levels and route Dante audio wherever required. A total of two analog and 10 Dante audio channels are available.



Real time monitoring of wireless system health, channel availability, and frequency management settings give you the confidence for a meeting free of interruptions and lost productivity.





# EASY TO DEPLOY

The all-in-one-design of Microflex Complete Wireless means meetings can happen anywhere. Automated frequency coordination with interference detection and avoidance, minimizes any complicated set up. This also enables meetings to run more smoothly without a technician present.

Setting up your next meeting is as simple as three steps:

## 1 MOUNT & POWER UP THE MXCWAPT ACCESS POINT

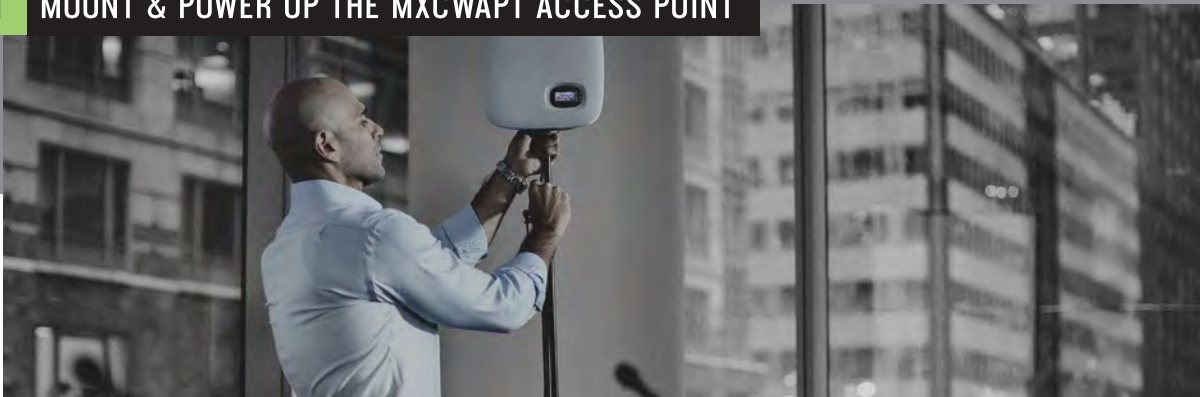

## 2 INSERT THE RECHARGEABLE BATTERY INTO EACH DELEGATE UNIT



## 3 DEPLOY & POWER ON DELEGATE UNITS WHERE NEEDED



## ADVANTAGES

**SHURE**

# TACKLE ANY SPACE

Need to outfit a meeting space with audio the day before a big meeting with 50 people? With Microflex Complete Wireless, that's no problem. Each participant gets their own microphone, loudspeaker, and control right in front of them. And when compared to the complexity required to properly equip a room like with conventional gear, MXCW wins everytime.

### MICROFLEX COMPLETE WIRELESS

**50** + **1** + **1**  
MXCW640  
CONFERENCE UNITS      MXCWAPT WIRELESS  
ACCESS POINT      POE-EQUIPPED  
NETWORK SWITCH

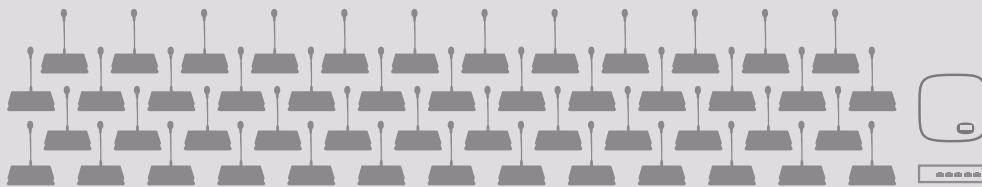

### TRADITIONAL NON-CONFERENCE SOLUTION

**50** + **50** + **8** + **4** + **1**  
GOOSENECK  
WIRED MICROPHONES      CABLES      CEILING  
LOUDSPEAKERS      TWO-CHANNEL  
POWER AMPLIFIERS      50-CHANNEL  
AUDIO MIXER

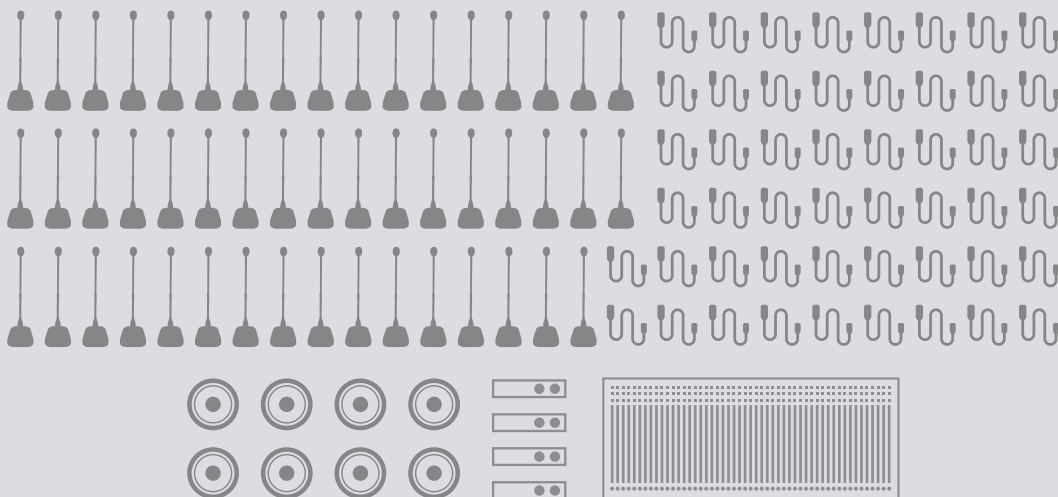



# SCALABLE FOR MANY APPLICATIONS

From an international conference to a city council or courtroom, Microflex Complete Wireless provides the premium audio intelligibility required for successful engagement between attendees – with convenient control to meet the specific needs of your application.



## FLEXIBLE ROOM

### Presentation Panel Discussion Q&A

Off-site meetings can be an expensive waste of time if attendees cannot fully participate in the discussion. Typical in-room sound systems are only designed to amplify the presenter's voice, and miss the contributions of other participants. Microflex Complete Wireless is a versatile audio solution that extends full coverage to every attendee without the labor of routing and securing audio cables. Network monitoring allows a technician to monitor battery levels from a PC.

### Audio System Components

- 01 **MXCW640**  
Wireless Touchscreen Conference Unit
- 02 **MXCW640**  
Wireless Touchscreen Conference Unit  
configured as Chairman
- 03 **MXCWNC**  
Networked Charging Station
- 04 **MXCWAPT**  
Wireless Access Point Transceiver

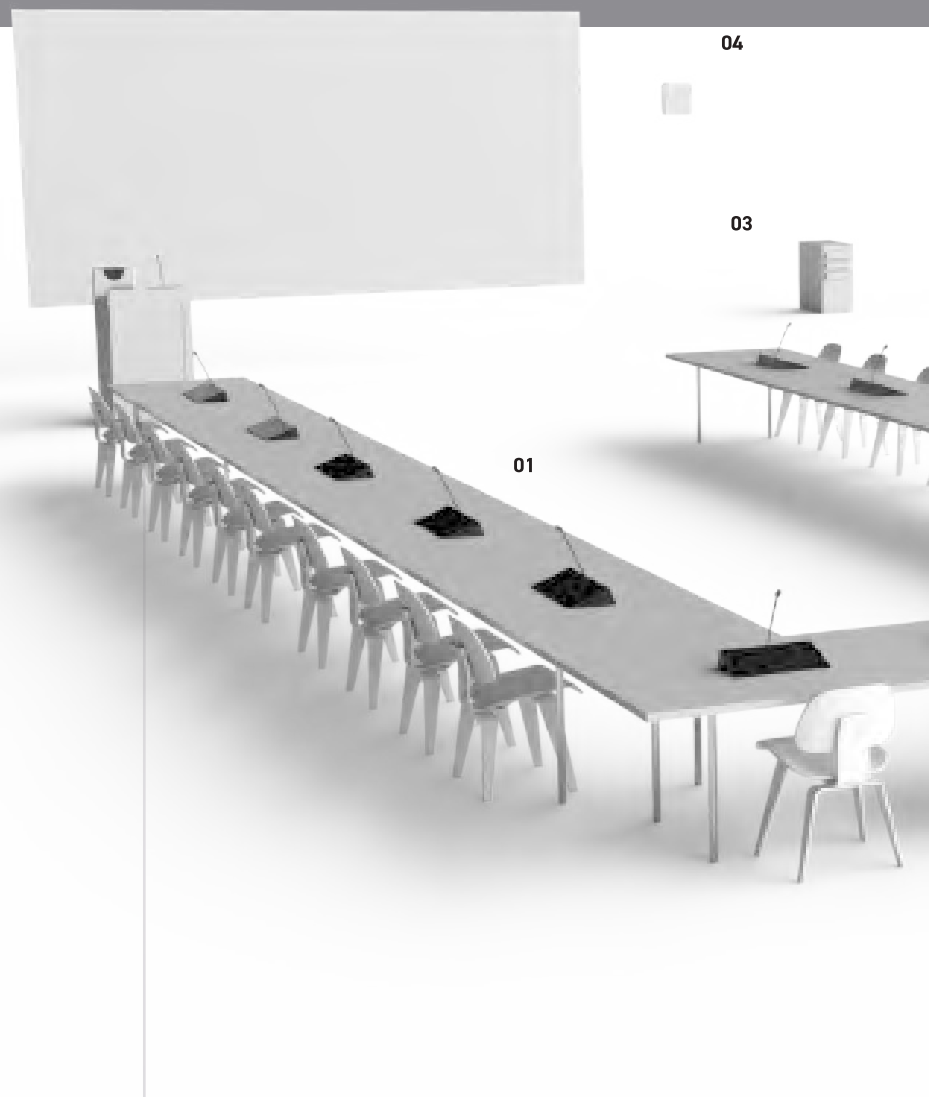

# APPLICATIONS

**SHURE**



02



ETHERNET



WIRELESS ENCRYPTED TRANSMISSION

# APPLICATIONS

**SHURE**

## BOARDROOM

**Discussion**  
**Conferencing**  
**Collaboration**  
**Presentation**

In boardrooms with long tables, it can be difficult to hear people seated at the far end. With Microflex Complete Wireless, each participant has their own conference unit with an integrated microphone and loudspeaker so that everyone can hear each other perfectly. Wireless convenience means there are no holes to drill and the system can be put away when not needed. Robust encryption keeps sensitive meeting content secure.

### Audio System Components

- 01** **MXCW640**  
Full Featured Conference Unit
- 02** **MXCWNCS**  
Networked Charging Station
- 03** **MXCWAPT**  
Wireless Access Point Transceiver
- 04** **P300-IMX**  
IntelliMix® Audio Conferencing Processor

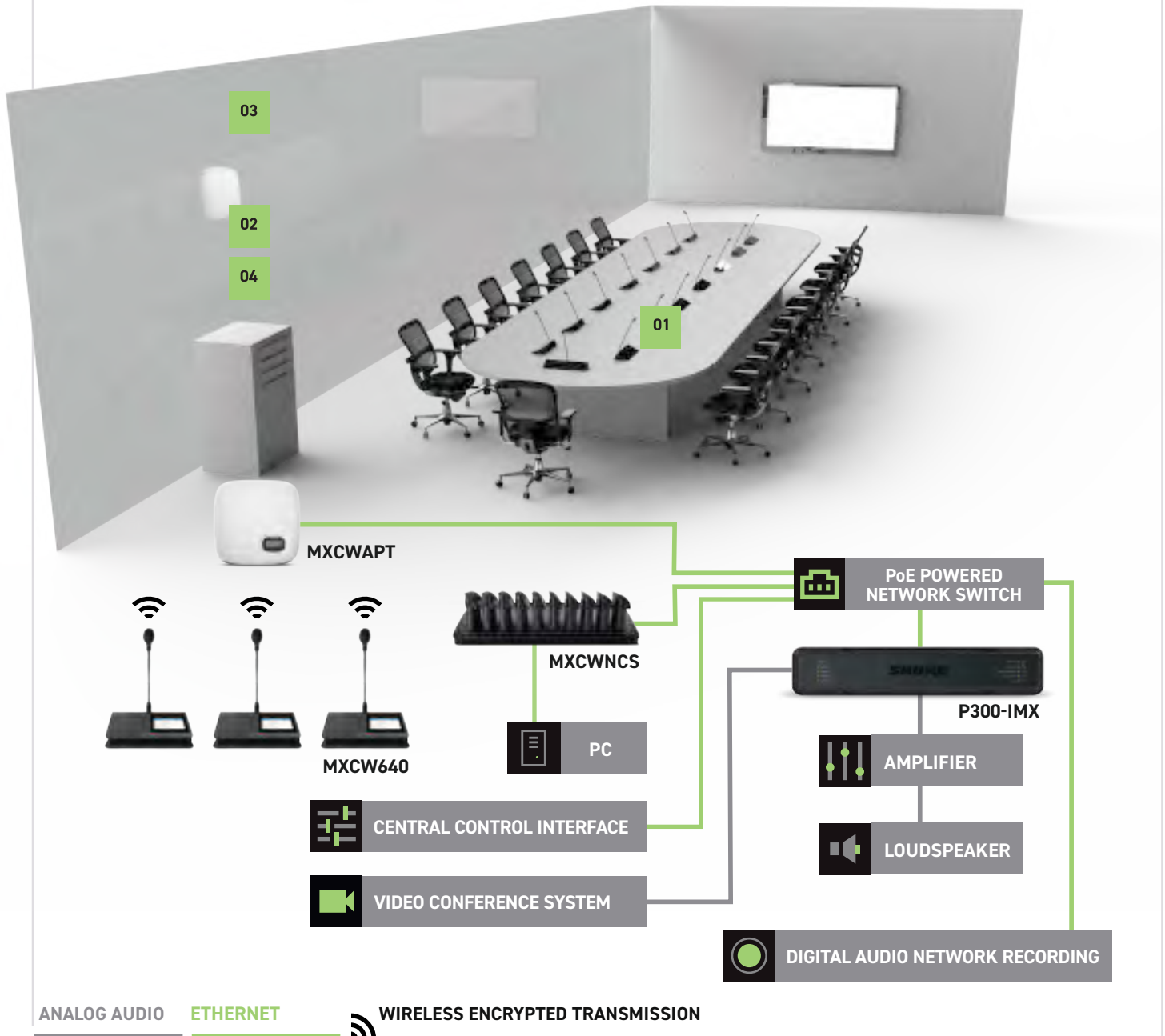

# APPLICATIONS

**SHURE**

## SEMINAR ROOM

**Presentation**  
**Discussion**  
**Remote Campus**

At seminars and training events, attendees need to be able to understand complex information and ask questions comfortably, while the instructor needs to know that learning is successful. Microflex Complete Wireless makes it easy for attendees to hear clearly, ask questions, and respond to instructor polls. The system can connect to third-party streaming equipment to include remote participants. Wireless convenience allows flexible seating to be reconfigured without moving cables.

### Audio System Components

- 01** **MXCW640**  
Wireless Touchscreen Conference Unit
- 02** **MXCWAPT**  
Wireless Access Point Transceiver
- 03** **MXCWNCs**  
Networked Charging Station

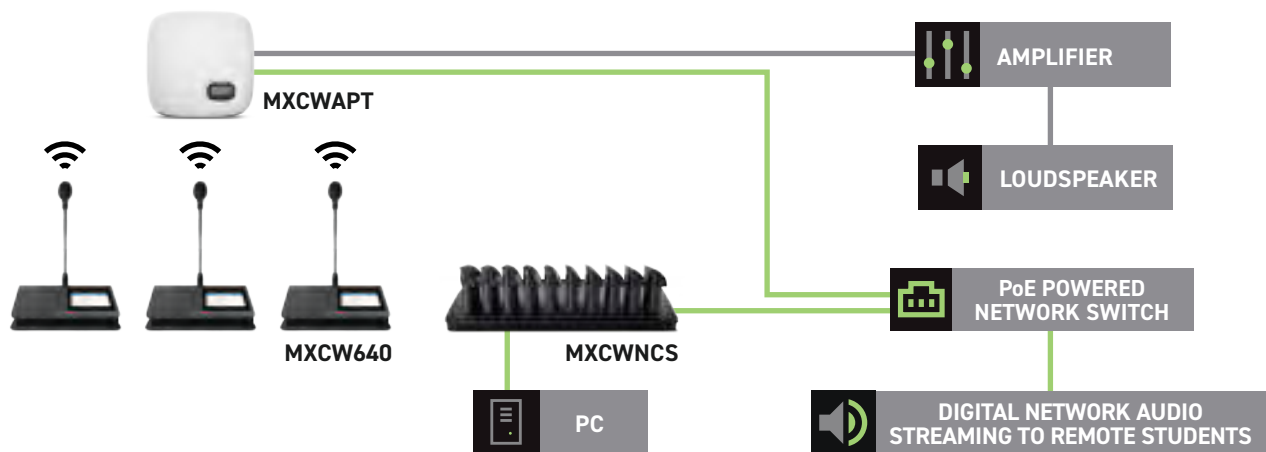

ANALOG AUDIO

ETHERNET



WIRELESS ENCRYPTED TRANSMISSION



**SHURE**

**SHURE**

# CONNECTION THAT REALLY CONNECTS

SHURE MICROFLEX® WIRELESS

OBJECTIVES  
1. CREATE MARKETING  
2. DEFINE KPI'S  
3. MESSAGING  
4. PERSONAS  
5. LANDING PAGE



**SHURE**

**SHURE**

# VIVID, LIFELIKE AUDIO FOR CONFERENCING.

MODERN AV CONFERENCING ENVIRONMENTS PROVIDE COMFORTABLE,  
PRODUCTIVE PLACES FOR PEOPLE TO MEET AND ENGAGE.

The Microflex Wireless platform was developed by Shure with innovative conferencing spaces in mind, providing flexible and elegant solutions for capturing and managing vivid, lifelike sound in managed meeting environments. Every system shares the same building blocks: intelligent rechargeable microphone transmitters and charging stations, discreet wireless access point transceivers, flexible audio network interfaces, and comprehensive software tools. Easy to configure and expand, Microflex Wireless easily scales from custom boardrooms to networked enterprises.



## PRISTINE AUDIO

Microflex microphone elements flawlessly capture the detailed characteristics of the human voice. Legendary Shure quality and reliability preserve the vocal nuances to ensure realistic and natural communication.

## TAILORED & DISCREET SOLUTIONS

With 2-, 4- or 8-channel configurations and a versatile offering of modern, low-profile wireless transmitters, Microflex Wireless systems fit any conferencing application and are designed to install easily and disappear into diverse AV environments.

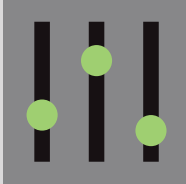

## INTELLIGENT RF PERFORMANCE

Transmitters become instantly active when removed from the Networked Charging Station. While the system is in use, the Access Point Transceiver actively scans the available spectrum, automatically coordinates clean frequencies for every microphone channel and moves away from unexpected interference.



## SCALABLE & NETWORK READY



Individual systems can be combined to support configurations of up to 80 compatible channels, or 160 channels in High Density mode (region dependent). Ethernet connectivity and Dante™ digital audio networking allow to connect to corporate networks for remote management and campus-wide implementation. Dante Domain Manager compatible.



## ADVANCED POWER MANAGEMENT

Smart lithium-ion rechargeable batteries deliver up to 9 hours of continuous use, ensuring that transmitters can operate for a full working day. Standby mode allows energy saving, and remaining battery life or charge details can be monitored remotely over the network, accurate to hours and minutes.

## SECURE TRANSMISSIONS

Wireless audio transmission is protected by AES-256 encryption to ensure unbreakable privacy and confidentiality. Corporate-uplink mode can be used to keep digital audio off the corporate network while still allowing remote monitoring and system control.



## COMPREHENSIVE SOFTWARE CONTROL

Integrated Microflex Wireless Control Software supports setup and allows real-time remote control of a system. Shure SystemOn™ Audio Asset Management Software provides a comprehensive solution for managing large-scale Microflex Wireless deployments, enabling AV / IT administrators to support campus-wide installations from one central platform.



## THIRD PARTY INTEGRATION

Microflex Wireless offers an expanded level of integration with numerous leading third party AV hardware and software solutions. The system is fully compatible with control and automation systems and other downstream equipment, reducing setup time and streamlining the workflow when using a complete AV system.

**SHURE**

# CONFIGURE TO YOUR NEEDS

EASY TO CONFIGURE AND EXPAND,  
MICROFLEX WIRELESS EASILY  
SCALES FROM CUSTOM BOARDROOMS  
TO NETWORKED ENTERPRISES.

**+ NEW**

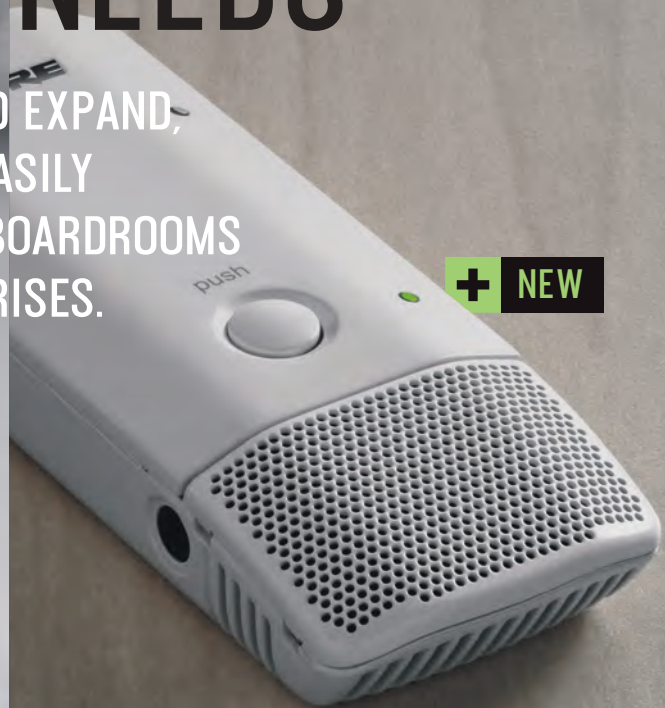

## **+ MXW6 BOUNDARY TRANSMITTER**

Low-profile wireless boundary microphone offers flexible placement on any surface in front of one or multiple speakers

Available with cardioid or omnidirectional pickup patterns

Low battery indicator LED

Earphone output for return channel audio

Concealed power switch prevents accidental powering off

Available in black or white

**SHURE**

Durable, lightweight handheld transmitter with integrated antenna

Accepts signature Shure vocal microphone capsules

Interchangeable microphone heads

Dual transmit antennas maximize signal strength depending on hand placement

**Microflex Wireless Microphone Features:**

AES-256 encryption

Advanced li-ion rechargeability; up to 9 hours continuous use

Programmable mute button

Full range audio (mic dependent)

Bi-directional wireless for real time remote control of settings

Up to 50 m (160 ft.) transmission range

Adjustable power limits to maximize the number of transmitters to operate in separate rooms

Range warning alert emits beeping sound when range exceeded

Connect to any standard USB power source for "always on" usage

Standby mode significantly extends battery life during periods of inactivity

CommShield® Technology prevents audible interference from consumer wireless devices



**+ MXW1 HYBRID BODYPACK**

Compact bodypack with integrated omni microphone perfect for use on a lanyard or in a shirt pocket, with external mic input and belt clip included for attachment to clothing

External mic input for easy connection to ear-worn and lavalier mics

Integrated omnidirectional microphone with external input auto switchover feature

Earphone output for return channel audio





**SHURE**

**+ MXW8 GOOSENECK BASE TRANSMITTER**

Stylish, contoured design with minimal footprint

Accepts Microflex modular gooseneck microphones available in multiple lengths with polar pattern and LED options

Programmable LED light ring

Earphone output for return channel audio

Concealed power switch prevents accidental powering off

Compatible with 5, 10, and 15 inch Microflex Modular Goosenecks

Available in black or white

**+ NEW**





**SHURE**

## **+** MXWAPT2 | MXWAPT4 | MXWAPT8 ACCESS POINT TRANSCEIVER

Low-profile Access Point Transceivers maintain two-way audio and data links with 2, 4 or 8 linked wireless microphones. The Access Point Transceiver features Power over Ethernet connectivity, is easily installed and connected to the network, and ships with wall/ceiling mounting plate and a paintable cover to match the room color.

Automated frequency coordination

2-, 4- or 8-channel models, up to 80 compatible channels per room in standard mode\*

High Density mode doubles the max. number of MXW transmitters, up to 160 channels\*\*

Bi-directional wireless for both audio signal and control data

AES-256 encryption

Dante™ digital networked audio enables audio routing over Ethernet to any Dante-enabled equipment

Powered over Ethernet by the Audio Network Interface

Compact design and slim profile (7"×7"×11/2") with paintable cover

Plenum rated for installation flexibility

\* Total number of channels is region dependent.

\*\* High Density mode available with MXW firmware version 5.x or later. Can be selected for each individual MXWAPT in the browser-based control interface.





**SHURE**

## **+** MXWANI4 | MXWANI8 AUDIO NETWORK INTERFACE

With per-channel analog outputs and a versatile 4 port gigabit Ethernet switch, these rack-mountable 4-channel and 8-channel units are the central point for connecting Microflex Wireless systems to teleconferencing and presentation AV networks.

4 or 8 block connector channel outputs

1 or 2 mono block connector inputs for return channel audio

4 port gigabit switch with optimized port configurations

Power over Ethernet (PoE) connection to the Access Point Transceiver

Front panel controls allow adjustment of input and output levels and channel muting and soloing

Supports Dante™ networking of digital audio for low latency transport and recording

Headphone output to solo audio channels



**SHURE**



## **+** MXWNC2 | MXWNC4 | MXWNC8 NETWORKED CHARGING STATIONS

Versatile 2-, 4- and 8-bay chargers include docking USB charge ports that accept any Microflex Wireless transmitter\*. Ethernet system connection supplies remote battery status monitoring via the control software and easy transmitter linking to the Access Point Transceiver.

Connects to the system over Ethernet

Monitor remaining battery life and charge levels in hours and minutes over the network

Easy linking of docked microphones to Access Point Transceivers

Charges to full in 2 hours; 50% charge in 1 hour

Front panel LEDs report 10, 25, 50, 75 and 100% levels

\*MXWNC2 not compatible with MXW8 Transmitter